

# "Math Is Cool" Masters — 2022-23

6<sup>th</sup> Grade — April 29, 2023

Sponsored by:

## **GENERAL INSTRUCTIONS applying to all tests:**

- *Good sportsmanship is expected throughout the competition by all involved (competitors and observers). Display of poor sportsmanship will result in disqualification.*
- *Competitors may not use calculators or any other aids on any portion of this contest.*
- *Unless stated otherwise:*
  - *Express all rational, non-integer answers as common fractions, except in problems dealing with money, where you should give the answer as a decimal rounded to the nearest cent.*
  - *For 5<sup>th</sup> grade and up, all fractions and ratios must be reduced to simplest form, all radicals must be simplified, and all denominators must be rationalized.*
  - *Do not round or approximate answers. Leave answers in terms of  $\pi$  or other irrational quantities (e.g.,  $\sqrt{2}$ ), where applicable.*
- *Units are not necessary as part of your answer, unless it is a problem that deals with time, in which case, AM or PM is required. However, if you choose to use units, they must be correct.*
- *Record all answers on the colored cover sheets in the answer column only.*
- *Be sure that the student name, school, team number, etc. has been filled out at the top of each answer sheet.*
- *Tests will be scored as a 0 if answers are not recorded correctly on the answer sheets.*
- *Blank answer sheets and answer sheets with no name will be scored as a 0.*

## **FINAL SCORES AND AWARDS**

*Individual awards are determined by both the Mental Math and Individual Test scores. Individual ties are broken based on the following, in this order: total scaled individual points, total number of correct answers on the Individual Test, Mental Math raw score, number of correct answers from Individual Test #31-40, number of correct answers from Individual Test #16-30, highest numbered question answered correctly on the Individual Test working backwards from #40.*

*Team (School) awards are based on the highest score from amongst each of the school's "teams of 4 students" in each event and is calculated as  $2 \cdot (\text{Sum of highest 3 Mental Math scores}) + 2 \cdot (\text{Multiple Choice}) + 6 \cdot (\text{Team}) + 1 \cdot (\text{Triple Jump}) + 1 \cdot (\text{College Bowl})$ , for approximate weights of 25%, 20%, 30%, 15% and 10% respectively. Team ties are broken based on highest event score in order of the events, starting with Mental Math.*

## **MENTAL MATH TEST** - 30 sec./quest., 8 problems, ~8%/25% of individ./team scores

*The proctor will read each question twice. You may not do any writing or talking while arriving at a solution. Record only your answer on your answer sheet. You may not change, cross out, erase, or write over an answer once you have written it down. The maximum wait time is 30 seconds after completion of the second reading of the question. Correct answers receive 1 point.*

## **INDIVIDUAL TEST** - 35 minutes, 40 problems, ~92% of individual score

*When you are prompted to begin, tear off the colored answer sheet and begin testing. No talking during this individual test. You will be given a 5 minute time warning. Correct answers receive 2 points for problems 1-30 and 3 points for 31-40 (in the scaled score).*

# "Math Is Cool" Masters – 2022-23

6<sup>th</sup> Grade – April 29, 2023

Final Score (out of 8)
------------------------

Room # \_\_\_\_\_ School Name \_\_\_\_\_ Student Name \_\_\_\_\_ Team # \_\_\_\_\_

## Mental Math - ~25% of team score & ~8% of individual score

All students in the room will concurrently be asked the same eight questions in this individual test. When it is time to begin, the proctor will read the first question twice. You may not do any writing or talking while arriving at a solution. Once you have a solution, record it on the sheet in front of you. You may not change or cross out answers once you have written an answer down. If there are eraser marks, write-overs, or crossed-out answers, they will be marked wrong. Once all students have laid their pencils on the desk, another question will be asked. If a student doesn't lay his or her pencil down, the maximum wait time is 30 seconds after completion of the second reading of the question before the next question is read. You may continue to work on a problem (in your head) while the next question is being read. The raw score is 1 point per correct answer.

STUDENT: DO NOT WRITE IN SHADED REGIONS (or anywhere else, other than the answer box)

Answer		Scorer 2	Scorer 1
		0 or 1	0 or 1
1			
2			
3			
4			
5			
6			
7			
8			
<b>6<sup>th</sup> Grade</b>		<b>TOTAL:</b>	

# "Math Is Cool" Masters — 2022-23

6<sup>th</sup> Grade — April 29, 2023

Key

## Mental Math Contest - Answer Key

30 seconds per question - ~25% of team score & ~8% of individual score

**SCORERS — Write-overs, Cross-outs, and Erasures Must be Marked Incorrect (0)**  
Bracketed items [...] in the answer key are optional.

### 6<sup>th</sup> Grade

Answer		
1	60 [%]	The probability of rain tomorrow is two fifths. As a percent, what is the probability that it will not rain tomorrow?
2	20 [minutes]	Jen rides her bike at an average rate of nine miles per hour. How many minutes does it take her to ride for three miles?
3	12[inches]	The perimeter of a regular octagon is ninety-six inches. In inches, what is the length of one of the sides of the octagon?
4	0 [prime numbers]	How many positive two-digit prime numbers have a five as their units digit?
5	4 [gum drops]	A jar has a mix of ten red gum drops, fifteen green gum drops, and twelve yellow gum drops. Except for their color, all of the gum drops are identical. How many gum drops must be pulled from the jar, without looking, to guarantee two gum drops of the same color?
6	10 [eggs]	A cake recipe calls for 3 cups of flour and 4 eggs. If the recipe is scaled up proportionately, how many eggs will be needed if seven and one-half cups of flour are used?
7	25	What is the mean of two to the first power, three to the second power, and four to the third power?
8	21 [= A + B]	As a reduced common fraction, the ratio of positive three-digit multiples of twenty to positive three-digit integers is A over B. What is the value of A plus B?

# "Math Is Cool" Masters — 2022-23

6<sup>th</sup> Grade — April 29, 2023

## Individual Contest

Record all answers on the colored cover sheet. 35 minutes, 40 problems, ~92% of individual score.

No talking during this individual test. A 5-minute time warning will be given.

Questions 1-30: 2 points each	
1	Evaluate: $110 + 130 + 150 + 170 - 500$
2	What is the sum of the next three numbers in the following arithmetic sequence? 13, 30, 47, 64, _____, _____, _____
3	A room has exactly three doors. In how many ways can a person enter the room by one door and leave the room by a different door?
4	What percent of 175 is 70?
5	Solve for x: $8x + 103 = 231$
6	What is the largest positive integer factor of the number 735, other than 735?
7	Mariah's scores in her last three rounds of golf were 81, 77, and 78. What score would she need on her next round to lower the mean score for these four rounds to 78?
8	A racecar drives at an average speed of 120 miles per hour. With this average speed, how long, in minutes, would it take the car to complete ten laps on a 2-mile track?
9	How many seconds are in 7 and a half minutes?
10	A 3-inch by 3-inch square has area A and a 6-inch by 6-inch square has area B. What is the value of A/B as a percent?
11	What is the product of 41 and 39?
12	My number is doubled. The result is then divided by 3 and then 10 is added. If the resulting number is 18, what is my number?
13	A jar has 12 blue marbles and 16 green marbles. As a reduced common fraction, the probability that a randomly selected marble is not blue is A/B. What is the value of A + B?
14	Let P represent a prime number. Let Q represent a positive even integer. What is the largest possible value of P, such that $P + Q = 11$ ?
15	An equilateral triangle has sides of length 8 inches. The length of one side is multiplied by 2, the length of another side is multiplied by 3 and the length of the third side is multiplied by 4 to make a new triangle. What is the number of inches in the perimeter of the new triangle?
<b>Continued on next page.</b>	

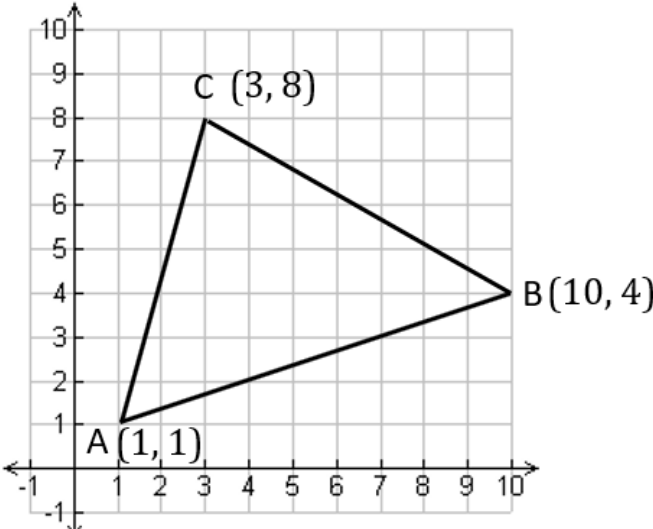
16	What is the largest possible median in a set of nine distinct positive integers all less than 21?
17	What is the greatest product of any two distinct integer factors of 24?
18	Let $D$ represent the number of dollars Jen has that she wants to use to purchase concert tickets. If she tries to purchase two tickets, she will be short by 30% of the total cost. If she purchases one ticket, she will have \$36 left over. In dollars, what is the cost of one ticket?
19	The cost for a first-class letter (envelope and contents) sent through the USPS is 63 cents for up to 1 ounce. On average a standard business envelope weighs 0.238 ounces and a piece of 8.5" x 11" paper weighs 0.1696 ounces. How many full sheets of paper can go in a standard business envelope before the letter exceeds 1 ounce?
20	How many ways are there to make 3 dollars with nickels and/or quarters?
21	<p>On a coordinate plane, the coordinates of the vertices of <math>\triangle ABC</math> are labeled as shown. The coordinates of <math>A</math> are each multiplied by two resulting in <math>A'</math>, the coordinates of <math>B</math> are each divided by two resulting in <math>B'</math> and only the <math>x</math>-coordinate of <math>C</math> is multiplied by three resulting in <math>C'</math>. What is the area of <math>\triangle A'B'C'</math> in square units?</p> 
22	A donkey takes 36 minutes to walk from point $A$ to point $B$ and the distance from point $A$ to point $B$ is $\frac{3}{4}$ of a mile. The donkey's average speed in miles per hour is $C.D$ , where $C$ is a single-digit integer and $D$ is a two-digit integer. What is the value of $C + D$ ?
23	Each letter in the expression $\frac{A}{B} + \frac{C}{D}$ , is replaced with one of the four digits 3, 4, 5, and 6, to make the largest possible sum and such that $A > C$ . As a percent, what is $B/A$ ?
24	Fern wants to make a sum greater than 40 by adding together some or all of the numbers in the following set: $\{1, 2, 3, 4, 5, 6, 7, 8, 9\}$ . She can't use the same number more than once, and the order she adds the numbers in doesn't matter. How many different ways can she do this?
25	For the function, $f(n) = \frac{n(n-1)}{2}$ , what is the sum of the ten function values resulting from integer inputs $n = 1$ through $n = 10$ ?
26	How many cubic inches are in one cubic foot?
27	What is the largest two-digit integer that has a remainder of 1 when divided by 3, a remainder of 3 when divided by 4, and a remainder of 4 when divided by 5?

Continued on next page.

28	Two cards are drawn from a standard deck without replacement. The probability as a reduced common fraction that the first card is an Ace and the second card is not a Face Card (Jack, Queen, or King) is $A/B$ . What is the value of $A + B$ ?
29	It takes Biff 50 seconds to paint one board and it takes Eho 60 seconds to paint the same board. If Biff and Eho work together, how many minutes will it take them to paint twenty-two such boards?
30	In the figure shown here, the diameter of the large circle is 18 centimeters. The three smaller circles are congruent, with their diameters coinciding with the diameter of the large circle. They are tangent to the large circle and each other as shown. The area of the shaded region is $A\pi \text{ cm}^2$ . What is the value of $A$ ?

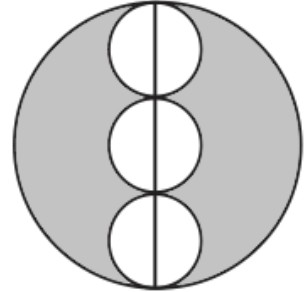

### Challenge Questions: 3 points each

31	A palindrome is an integer that reads the same forwards and backwards, such as 121. A 5-digit positive palindrome integer is divided by 111. As a reduced common fraction, the probability that the quotient is an integer and also a palindrome is $A/B$ . What is the value of $A + B$ ?
32	What is the sum of the integer solutions of $x$ in the following inequality? $\frac{1}{30} < \frac{2x}{5} - \frac{1}{6} < \frac{9}{10}$
33	How many positive three-digit base-9 numbers are there?
34	The given expression simplifies to a reduced common fraction in the form $A/B$ . What is the value of $A + B$ ?
	$2 + \frac{2}{2 + \frac{2}{2 + \frac{2}{3}}}$
35	In the figure shown here, $\triangle ABC$ and $\triangle EDC$ are right triangles, $\triangle ABC \sim \triangle EDC$ , and the ratio of $DE/BA = 0.75$ . If $CD = 6 \text{ cm}$ and $DE = 15 \text{ cm}$ , then $AE = P\sqrt{Q} \text{ cm}$ , where $P$ is a single-digit prime number and $Q$ is a two-digit prime number. What is the value of $P + Q$ ?
36	Given that: $x + \frac{1}{x} = n$ , and $x^2 + \frac{1}{x^2} = n$ , where $x$ and $n$ are real numbers, find the sum of all possible values of $n$ .

Continued on next page.

37	A water tank can be filled by pipe A in 4 hours and by pipe B in 6 hours. Pump A is turned on and then after two hours pump B is also turned on. How many minutes after pump A was turned on will the tank be full?
38	<p>A, B, and C represent single digits in the following addition problem.</p> $\begin{array}{r} A A A \\ B B B \\ + C C C \\ \hline B A A C \end{array}$ <p>If A, B, and C, are distinct positive integers, what is the value of <math>A + B + C</math>?</p>
39	Whenever Tiger putts, he has an 80% chance of making the putt, independent of his previous putts. As a reduced common fraction, the probability of him making at least 1 of his next 3 putts is $A/B$ . What is the value of $A + B$ ?
40	<p>A <math>10^{\text{th}}</math> integer, A, when added to the following set, results in the median of the set equaling the mean of the set. What is the sum of all possible values of A?</p> <p style="text-align: center;">{13, 15, 21, 28, 33, 38, 42, 48, 51}</p>

# "Math Is Cool" Masters - 2022-23

**KEY**

## 6<sup>th</sup> Grade Individual Contest - Answer Key

SCORERS: Bracketed [...] items in answer key are optional. Just mark the score as 0 or 1 and add up those values to reflect total correct.  
First Scorer - use the right-hand columns so 2<sup>nd</sup> scorer can do a blind scoring.

	Answer
1	60
2	294
3	6 [ways]
4	40 [%]
5	[x =] 16
6	245
7	76
8	10 [minutes]
9	450 [seconds]
10	[A/B =] 25 [%]
11	1599
12	12
13	[A + B =] 11
14	[P =] 7
15	72 [inches]

	Answer
16	16
17	288
18	[\$] 90 [dollars] or [\$] 90.00 [dollars]
19	4 [sheets]
20	13 [ways]
21	9 [units <sup>2</sup> ]
22	[C + D =] 26
23	50 [%]
24	7 [ways]
25	165
26	1728 [in <sup>3</sup> ]
27	79
28	[A + B =] 18
29	10 [minutes]
30	[A =] 54

	Answer
31	[A + B =] 46
32	3
33	648 [numbers]
34	[A + B =] 41
35	[P + Q =] 36
36	2 [n = ]
37	192 [minutes]
38	[A + B + C] = 18
39	[A + B =] 249
40	113



# "Math Is Cool" Masters - 2022-23

Total Correct (all columns)
-----------------------------

Room # \_\_\_\_\_

SCHOOL NAME \_\_\_\_\_

STUDENT NAME \_\_\_\_\_

Team # \_\_\_\_\_

## 6<sup>th</sup> Individual Contest - Score Sheet

STUDENTS: DO NOT WRITE IN SHADED REGIONS

	Answer	1 or 0	1 or 0
1			
2			
3			
4			
5			
6			
7			
8			
9			
10			
11			
12			
13			
14			
15			
<b>1-15 TOTAL:</b>			

	Answer	1 or 0	1 or 0
16			
17			
18			
19			
20			
21			
22			
23			
24			
25			
26			
27			
28			
29			
30			
<b>16-30 TOTAL:</b>			

	Answer	1 or 0	1 or 0
31			
32			
33			
34			
35			
36			
37			
38			
39			
40			
<b>31-40 TOTAL:</b>			

# "Math Is Cool" Masters — 2022-23

6<sup>th</sup> Grade — April 29, 2023

## Team Multiple Choice Contest

REFER TO THE FOLLOWING INFORMATION FOR PROBLEMS #1 THROUGH #3.

The table shows the population of wolves and moose in Isle Royale National Park in Michigan from 1980 to 2019.

One of the two untitled histograms below represents the wolf data, and the other represents the moose data. On a histogram, the frequency of a bar indicates the number of times that the population was in the interval that corresponds with the bar. For example, if a bar has a frequency of 7, it means that there were 7 data values that fell within that data interval.

Year	# of Wolves	# of Moose	Year	# of Wolves	# of Moose
1980	50	664	2000	29	850
1981	30	650	2001	19	900
1982	14	700	2002	17	1000
1983	23	900	2003	19	900
1984	24	811	2004	29	750
1985	22	1062	2005	30	540
1986	20	1025	2006	30	385
1987	16	1380	2007	21	450
1988	12	1653	2008	23	650
1989	11	1397	2009	24	530
1990	15	1216	2010	19	510
1991	12	1313	2011	16	515
1992	12	1600	2012	9	750
1993	13	1880	2013	8	975
1994	15	1800	2014	9	1050
1995	16	2400	2015	3	1250
1996	22	1200	2016	2	1300
1997	24	500	2017	2	1600
1998	14	700	2018	2	1500
1999	25	750	2019	14	2060

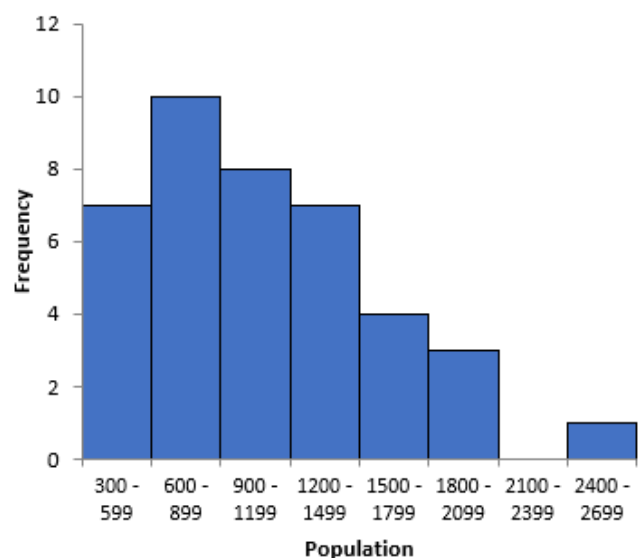
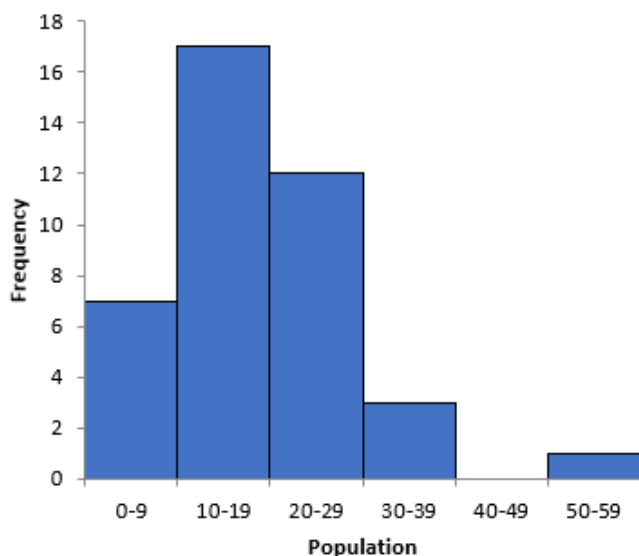

1	<p>During what year was the wolf population its highest during this 40-year period in Isle Royale National Park?</p> <p>A) 2006      B) 2005      C) 1995      D) 1981      E) 1980</p>
2	<p>What is the sum of the three moose population numbers corresponding with the bar having frequency 3 and the one wolf population number corresponding with the bar with frequency 1 on their respective histograms?</p> <p>A) 492      B) 2490      C) 5742      D) 5790      E) 5838</p>
3	<p>The stem-and-leaf plot below is for the wolf data.</p> <pre> 0   2, 2, 2, 3, 8, 9, 9 1   1, 2, 2, 2, 3, 4, 4, 4, 5, 5, 6, 6, 6, 7, 9, 9, 9 2   0, 1, 2, 2, 3, 3, 4, 4, 4, 5, 9, 9 3   0, 0, 0 4   5   0 </pre> <p>If three numbers are randomly selected without replacement from the data set, what is the probability that they will each be the same number, in other words, one of the modes?</p> <p>A) 7/9880      B) 3/4940      C) 1/1976      D) 1/2470      E) 3/9880</p>

Continued on Next Page

REFER TO THE FOLLOWING INFORMATION FOR PROBLEMS #4 THROUGH #6.

Figure A below is a 12 x 16 x 20-centimeter rectangular prism with a hole passing horizontally through its center that is also in the shape of a rectangular prism. The bases of the rectangular-prism-shaped hole are 8 x 9 centimeters and are in the same plane as the right and left faces of the large prism.

**Figure A**

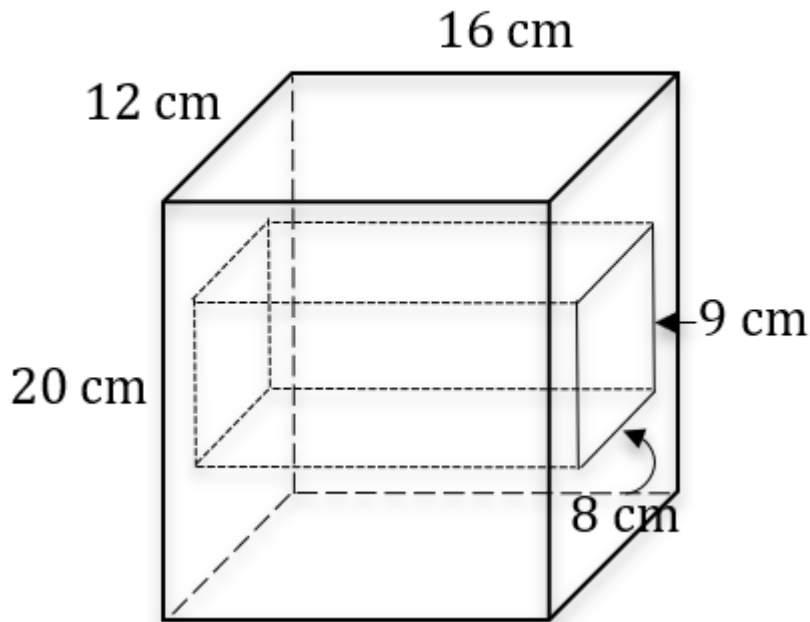

4	<p>What is the volume of the rectangular-prism-shaped hole in Figure A?</p> <p>A) 688 cm<sup>3</sup>   B) 864 cm<sup>3</sup>   C) 1152 cm<sup>3</sup>   D) 1440 cm<sup>3</sup>   E) 3840 cm<sup>3</sup></p>
5	<p>Including edges on the interior and exterior of the rectangular-prism-shaped hole, what is the sum of the lengths of all the edges in Figure A?</p> <p>A) 340 cm   B) 324 cm   C) 308 cm   D) 284 cm   E) 260 cm</p>
6	<p>Assume the interior faces of the rectangular-prism-shaped hole are part of the surface area of Figure A. What is the surface area of Figure A?</p> <p>A) 1152 cm<sup>2</sup>   B) 1760 cm<sup>2</sup>   C) 1904 cm<sup>2</sup>   D) 2048 cm<sup>2</sup>   E) 2120 cm<sup>2</sup></p>

Continued on Next Page

	<p><b>USE THE FOLLOWING INFORMATION TO SOLVE PROBLEMS #7 THROUGH #10.</b></p> <p>In the three infinite sequences below, 9 is the first term in sequence A, and 1 is the first term in sequence B and in sequence C.</p> <p>A: 9, 22, 35, 48, 61, 74, . . .</p> <p>B: 1, 3, 6, 10, 15, 21, . . .</p> <p>C: 1, 3, 9, 27, 81, 243, . . .</p>
7	<p>What is the sum of the next number in each of the three series?</p> <p>A) 874      B) 864      C) 854      D) 844      E) 834</p>
8	<p>What is the mean of the first 8 numbers in series A?</p> <p>A) 52.625      B) 54      C) 54.5      D) 55      E) 56.125</p>
9	<p>Select the answer which gives the correct rule for each series, where n stands for the series of positive integers, 1, 2, 3, . . .</p> <p>A) A: <math>13n + 4</math>, B: <math>n(n-1)/2</math>, C: <math>3^{n-1}</math></p> <p>B) A: <math>9n + 13</math>, B: <math>n(n-1)/2</math>, C: <math>3^n</math></p> <p>C) A: <math>13n - 4</math>, B: <math>n(n-1)/2</math>, C: <math>3^n</math></p> <p>D) A: <math>13n</math>, B: <math>n(n+1)/2</math>, C: <math>3^n</math></p> <p>E) A: <math>13n - 4</math>, B: <math>n(n+1)/2</math>, C: <math>3^{n-1}</math></p>
10	<p>Let P represent the largest 3-digit integer in series A, let Q represent the largest 3-digit integer in series B, and let R represent the largest 3-digit integer in series C. Given the numbers P, Q and R, which of the following shows the ratio of prime numbers to composite numbers for the three values?</p> <p>A) 0:3      B) 1:2      C) 2:1      D) 3:0      E) 3:1</p>

# "Math Is Cool" Masters — 2022-23

6<sup>th</sup> Grade — April 29, 2023

**Key**

## Team Multiple Choice Contest - Answer Key

### 6<sup>th</sup> Grade

Correct responses are worth 2 points, incorrect responses are worth -1 point, and absence of a response is worth 0 points.

	Answer
1	E
2	D
3	A
4	C
5	B
6	C
7	D
8	C
9	E
10	B

# "Math Is Cool" Masters — 2022-23

6<sup>th</sup> Grade — April 29, 2023

Final Score (out of 20)

Room #

School Name

Team #

## Team Multiple Choice Contest - 15 minutes - ~20% of team score

*This test is the only test where you will be penalized for incorrect responses. You will receive two points for a correct letter response, zero points for leaving it blank, and minus one point for an incorrect response. When you are prompted to begin, tear off the colored answer sheet, pass out a copy of the test to each team member, and begin testing. ONLY a letter response should be listed as an answer on this answer sheet.*

**Correct responses are worth 2 points, incorrect responses are worth -1 point, and absence of a response is worth 0 points.**

**STUDENTS: DO NOT WRITE IN SHADED REGIONS**

		Scorer 2	Scorer 1
Answer		-1, 0, or 2	-1, 0, or 2
1			
2			
3			
4			
5			
6			
7			
8			
9			
10			
<b>6<sup>th</sup> Grade</b>		<b>TOTAL:</b>	

# "Math Is Cool" Masters — 2022-23

6<sup>th</sup> Grade — April 29, 2023

## Team Contest

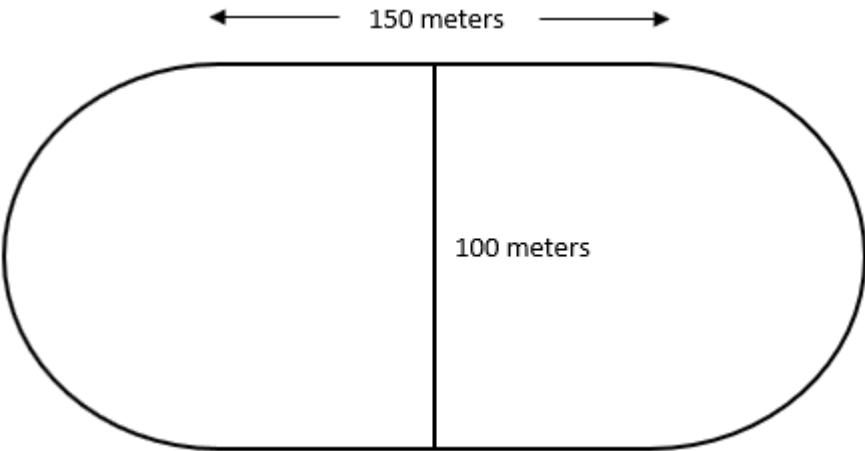
1	Evaluate: $4(17 - 11) + 320/64$
2	How many inches are in 7 yards?
3	Let $a \cdot b = ab + ba$ ( $a$ times $b$ plus $b$ times $a$ ). What is the value of $3 \cdot 6$ ?
4	If 4 apples cost the same as 12 bananas and 6 bananas cost the same as 1 pear, how many apples cost the same as 5 pears?
5	<p>A track has two straight sections that are each 150 meters long and two semicircular ends, each with a diameter of 100 meters as shown below. In terms of <math>\pi</math>, the perimeter of the track is <math>A\pi + B</math> meters. What is the value of <math>A + B</math>?</p>  <p>The diagram shows a track with two straight sections and two semicircular ends. A horizontal double-headed arrow above the top straight section is labeled "150 meters". A vertical line segment inside the track, connecting the two straight sections, is labeled "100 meters".</p>
6	Buzz is traveling to the Planet Zog, which is twenty-six light years away, and his spaceship travels thirteen light years every twenty-four days. A quarter of the way through the trip, he realizes he forgot his ray blaster at home and goes back for it. In days and from the moment he first leaves, how long does it take for Buzz to reach the Planet Zog?
7	An arithmetic sequence can be described by the rule $2n + 1$ , where $n$ can be any integer. What is the sum of the three largest negative numbers in the sequence?
8	As a reduced common fraction, the probability that the product of any three randomly selected and not necessarily distinct single-digit positive integers is 12 is $A/B$ . What is the value of $A + B$ ?

Continued on next page.



9 How many rectangles of any size are in the figure below?

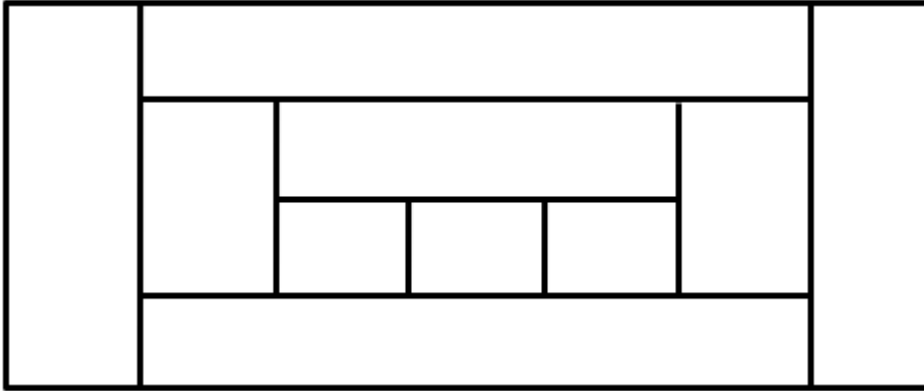

10 Enrique's locker combination is a positive three-digit integer, where each digit is a unique number from 1 to 9 inclusive. One morning while opening his locker, Enrique realized that if he multiplied the three digits of the number together, the product would be exactly one-fourth of the number that is his locker combination. What is Enrique's locker combination?

# "Math Is Cool" Masters — 2022-23

6<sup>th</sup> Grade — April 29, 2023

**Key**

## Team Contest - Answer Key

### 6<sup>th</sup> Grade

	Answer
1	29
2	252 [inches]
3	36
4	10 [apples]
5	[A + B =] 400
6	72 [days]
7	-9
8	[A + B =] 248
9	22 [rectangles]
10	384

# "Math Is Cool" Masters — 2022-23

6<sup>th</sup> Grade — April 29, 2023

Final Score (out of 10)

Room #

School Name

Team #

## Team Contest - 15 minutes - ~30% of team score

When you are prompted to begin, tear off the colored answer sheet and give a copy of the test to each of your team members and begin testing. Each problem is scored as a 1 or 0. Record all answers on this colored answer sheet.

STUDENTS: DO NOT WRITE IN SHADED REGIONS

Answer		Scorer 2	Scorer 1
		0 or 1	0 or 1
1			
2			
3			
4			
5			
6			
7			
8			
9			
10			
6 <sup>th</sup> Grade		TOTAL:	

# "Math Is Cool" Masters — 2022-23

6<sup>th</sup> Grade — April 29, 2023

## Linda Moore Triple Jump

1	What is the next number in the following arithmetic sequence? 513, 492, 471, 450, _____
2	Let $A$ be the median of data set #1, let $B$ be the median of data set #2, and let $C$ be the median of data set #3. What is the mean of $A$ , $B$ , and $C$ ? Data set #1 - {11, 13, 17, 19, 23, 29, 31} Data set #2 - {25, 50, 75, 100, 125, 150, 175} Data set #3 - {1, 8, 27, 64, 125, 216, 343}
3	Riley eats $\frac{1}{3}$ of a cake and Beau eats $\frac{1}{15}$ of the cake. After this, what percent of the cake has not been eaten?
4	How many ways can you make 95 cents with dimes and/or quarters?
5	Bowl $A$ contains 13 green skittles, bowl $B$ contains 16 red skittles, and bowl $C$ contains 15 orange skittles. Three green skittles are moved to bowl $B$ , four red skittles are moved to bowl $C$ and five orange skittles are moved to bowl $A$ . Which bowl has the fewest skittles in it after these moves? Answer 1 for bowl $A$ , 2 for bowl $B$ , 3 for bowl $C$ , or 4 if no one bowl has the fewest skittles.
6	A survey is given to 90 people, and everyone chooses one of four options: 1) plays golf, but not tennis, 2) plays golf, but not tennis, 3) plays both golf and tennis, 4) plays neither. Based on the results, the probability that someone chose option 1 is $\frac{5}{18}$ , the probability that someone chose option 2 is $\frac{1}{3}$ , and the probability that someone chose option 3 is $\frac{2}{15}$ . How many respondents chose option 4?
7	Twin primes are pairs of prime numbers that differ by 2, such as 3 and 5. Consecutive pairs of twin primes are two pairs of twin primes with no other pair of twin primes between them, such as (17, 19) and (29, 31), and these two pairs of twin primes have the even integers 20, 22, 24, 26, and 28 between them. What is the greatest number of even integers between any two pairs of consecutive two-digit twin primes?
8	Let $A$ be a positive three-digit integer in which the units digit is larger than the tens digit, and the tens digit is larger than the hundreds digit. What is the smallest value of $A$ , such that four times $A$ , or $4A$ , is also a three-digit integer with three different digits and $A$ and $4A$ have no digits in common?

Continued on next page.

9 The second term of a six-term geometric sequence is 7 and the fifth term is 189. As a reduced common fraction, the sum of the first and sixth terms of the sequence is  $A/B$ . What is the value of  $A + B$ ?

10 The area of the small square that is inscribed in the circle is  $9 \text{ cm}^2$ . The combined area in  $\text{cm}^2$  of all the shaded regions, including the small square is  $A - \frac{B\pi}{C}$ , where  $\frac{B\pi}{C}$  is in terms of  $\pi$  and in lowest terms, and  $A$ ,  $B$ , and  $C$  are positive integers. What is the value of  $A + B + C$ ?

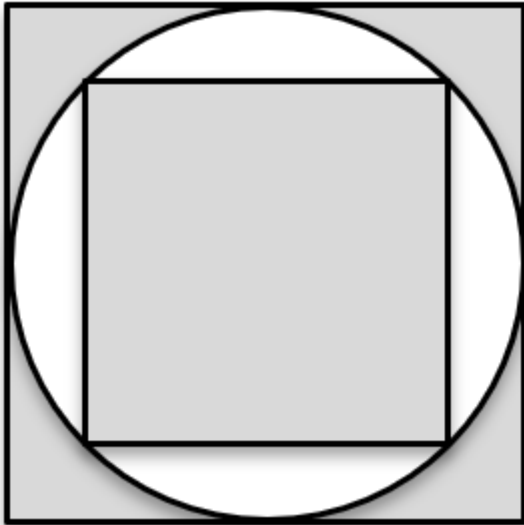

# "Math Is Cool" Masters — 2022-23

6<sup>th</sup> Grade — April 29, 2023

**Key**

**Linda Moore Triple Jump - Answer Key**

## 6<sup>th</sup> Grade

	Answer
1	429
2	61
3	60 [%]
4	2 [ways]
5	3 [bowl C]
6	23 [respondents]
7	8 [even integers]
8	[A =] 126
9	[A + B =] 1711
10	[A + B + C =] 38

# "Math Is Cool" Masters — 2022-23

6<sup>th</sup> Grade — April 29, 2023

Final Score (out of 10)

Room #

School Name

Team #

## Linda Moore Triple Jump - 15 minutes - ~30% of team score

When you are prompted to begin, tear off the colored answer sheet and give a copy of the test to each of your team members and begin testing. Each problem is scored as a 1 or 0. Record all answers on this colored answer sheet.

STUDENTS: DO NOT WRITE IN SHADED REGIONS

Answer		Scorer 2	Scorer 1
		0 or 1	0 or 1
1			
2			
3			
4			
5			
6			
7			
8			
9			
10			
6 <sup>th</sup> Grade		TOTAL:	

# "Math Is Cool" Masters — 2022-23

6<sup>th</sup> Grade — April 29, 2023

---

---

Room #

---

---

School Name

---

---

Team #

## Total Score for Each Round

College Bowl #1 (10 Possible)	College Bowl #2 (10 Possible)	College Bowl #3 (10 Possible)

DO NOT USE TALLY MARKS ON THIS SHEET. WRITE THE TOTAL SCORE FOR EACH ROUND.

# "Math Is Cool" Masters — 2022-23

6<sup>th</sup> Grade — April 29, 2023

---

---

Room #

---

---

School Name

---

---

Team #

## Total Score for Each Round

College Bowl #1 (10 Possible)	College Bowl #2 (10 Possible)	College Bowl #3 (10 Possible)

DO NOT USE TALLY MARKS ON THIS SHEET. WRITE THE TOTAL SCORE FOR EACH ROUND.



# "Math Is Cool" Masters — 2022-23

6<sup>th</sup> Grade — April 29, 2023

Proctor  
Copy

## Mental Math Contest

**MENTAL MATH** - 30 seconds per question - ~25% of team score & ~8% of individual score

*All students in the room will concurrently be asked the same eight questions in this individual test. When it is time to begin, the proctor will read the first question twice. You may not do any writing or talking while arriving at a solution. Once you have a solution, record it on the sheet in front of you. **You may not change or cross out answers once you have written an answer down. If there are eraser marks, write-overs, or crossed-out answers, they will be marked wrong.** Once all students have laid their pencils on the desk, another question will be asked. If a student doesn't lay his or her pencil down, the maximum wait time is 30 seconds after completion of the second reading of the question before the next question is read. You may continue to work on a problem (in your head) while the next question is being read. The raw score is 1 point per correct answer.*

1	The probability of rain tomorrow is two fifths. As a percent, what is the probability that it will not rain tomorrow?	60 [%]
2	Jen rides her bike at an average rate of nine miles per hour. How many minutes does it take her to ride for three miles?	20 [minutes]
3	The perimeter of a regular octagon is ninety-six inches. In inches, what is the length of one of the sides of the octagon?	12[inches ]
4	How many positive two-digit prime numbers have a five as their units digit?	0 [prime numbers]
5	A jar has a mix of ten red gum drops, fifteen green gum drops, and twelve yellow gum drops. Except for their color, all of the gum drops are identical. How many gum drops must be pulled from the jar, without looking, to guarantee two gum drops of the same color?	
6	A cake recipe calls for 3 cups of flour and 4 eggs. If the recipe is scaled up proportionately, how many eggs will be needed if seven and one-half cups of flour are used?	10 [eggs]
7	What is the mean of two to the first power, three to the second power, and four to the third power?	
8	As a reduced common fraction, the ratio of positive three-digit multiples of twenty to positive three-digit integers is A over B. What is the value of A plus B?	21 [= A + B]

# "Math Is Cool" Masters — 2022-23

6<sup>th</sup> Grade — April 29, 2023

Key

## COLLEGE BOWL ROUND #1

#	Problem	Answer
1	What is forty percent of twenty percent of one hundred?	8
2	A jar contains eleven sugar cookies and seven oatmeal cookies. As a reduced common fraction, the probability that two randomly selected cookies from the jar are both oatmeal is $A$ over $B$ . What is the value of $A$ plus $B$ ?	$[A + B = ] 58$
3	How many square meters are in one-half of a square kilometer?	500,000 [square meters]
4	Let $WX$ and $YZ$ each represent a two-digit integer. If the digits $W$ , $X$ , $Y$ and $Z$ are all different and none of them is zero, what is the smallest possible value of the product of $WX$ and $YZ$ ?	312
5	Some kangaroos can travel thirty miles per hour and hop a horizontal distance of twenty-four feet. At these rates, how many hops would a kangaroo travel in one hour?	6600 [hops]
6	What is the value of $K$ , such that the linear equation $Y$ equals $KX$ plus five has a solution point of two comma nine?	$[k = ] 2$
7	If $A$ plus three equals $B$ and $B$ minus four equals $C$ , then $A$ equals $C$ plus $D$ . What is the value of $D$ ?	$[D = ] 1$
8	The ratio of dogs to cats in an animal shelter is thirty-two to twenty-one. If there are one hundred and fifty-nine total dogs and cats in the shelter combined, how many of the animals are cats?	63 [cats]
9	Let eighty divided by fifteen equal $X$ . How many minutes are in $X$ hours?	320 [minutes]
10	The lengths of Fido's last three walks have been twenty-three, seventeen, and thirty-four minutes. How many minutes should the next walk be such that the average length of all four walks is twenty-five minutes?	26 [minutes]

# "Math Is Cool" Masters — 2022-23

6<sup>th</sup> Grade — April 29, 2023

Key

## COLLEGE BOWL ROUND #2

#	Problem	Answer
1	What is seven to the fourth power?	2401
2	Ishan is looking for a needle in a haystack. It takes him five minutes to sift through two cubic feet of hay. How long, in minutes, does it take Ishan to sift through thirty cubic feet of hay?	75 [minutes]
3	How many composite numbers are there from forty to forty-nine, inclusive?	7 [numbers]
4	What is the mean of the square root of one hundred, the cube root of one hundred twenty-five, and the fourth root of eighty-one?	6
5	It takes nine workers nine days to build nine walls. Working at the same rate, how many days does it take two workers to build eighteen walls?	81 [days]
6	The ratio of the angles in a triangle is one to three to eight. What is the angle measure, in degrees, of the largest angle?	120 [degrees]
7	Each hour of the day one through twelve, a bell tolls the same number of times as the time of day. It also tolls eight times each hour to make a melody prior to tolling the time of day. How many total tolls are there in one twelve-hour stretch?	174 [tolls]
8	Twice my number minus half of my number equals eighteen. What is my number?	12
9	Evaluate one thousand three hundred seventy-eight divided by twenty-six.	53
10	The first three terms of an arithmetic sequence are three, seventeen, and thirty-one. What is the seventh term in the sequence?	87

# "Math Is Cool" Masters — 2022-23

6<sup>th</sup> Grade — April 29, 2023

Key

## COLLEGE BOWL ROUND #3

#	Problem	Answer
1	The median of all positive two-digit integers is A point B, where A is a two-digit integer and B is a single-digit integer. What is the value of A plus B?	$[A + B =] 59$
2	Alf is taller than Barb, Barb is taller than Cam, Doug, and Evy. As a common fraction, the ratio of persons who could be the shortest in the group to persons who could not be the shortest is P over Q. What is P minus Q?	$[P - Q =] 1$
3	What is the remainder when three thousand twenty-one is divided by fifteen?	6
4	The height of a triangle is four times the base. The area of the triangle is ninety-eight square centimeters. In centimeters, what is the height of the triangle?	28 [cm]
5	In a group of eleven pickleballers, two are left-handed. As a reduced common fraction, the probability that exactly one of three randomly selected players is left-handed is A over B. What is the value of A + B?	$[A + B =] 79$
6	A Mersenne prime is a prime number that can be expressed as negative one plus two to the power of a positive integer N. How many values of N from one to six inclusive result in Mersenne primes?	3 [values]
7	On Jeb's first six shots on a hole in miniature golf the ball gets closer to the hole by exactly half its remaining distance to the hole. After six shots, the ball is one foot from the hole. How many feet from the hole was the ball originally?	64 [feet]
8	How many yards are in one fourth of a mile?	440 [yds]
9	How many elbow bumps occur in a room of nineteen people if each person bumps elbows with every other person once?	171 [elbow bumps]
10	If three-halves X plus fifteen-halves equals twenty-seven halves, what is the value of X?	$[x =] 4$

# "Math Is Cool" Masters — 2022-23

6<sup>th</sup> Grade — April 29, 2023

Key

## COLLEGE BOWL ROUND #4

#	Problem	Answer
1	How many positive integer factors does the number one hundred have?	9 [factors]
2	A certain wall has an area of one hundred and seventy-one square feet. Biff paints two-ninths of the wall and Eho paints the rest. How many square feet are in the section that Eho paints?	133 [ft <sup>2</sup> ]
3	What is the mean of the following five numbers: ninety, forty, thirty, twenty, and ten?	38
4	A rectangle has dimensions twelve by thirty-two inches. Four triangles are created by drawing the diagonals. In square inches, what is the area of one of these triangles?	96 [in <sup>2</sup> ]
5	Anya is four years older than Ben. Two years ago, Anya was three times Ben's age. How old is Ben right now, in years?	4 [years old]
6	Varun averaged thirty miles per hour driving to work. On his drive back home, he averaged twenty-four miles per hour, and it took three minutes longer than the drive to work. What was the total number of minutes spent driving to and from work?	27 [min]
7	The first term of a decreasing geometric series is five hundred seventy-six, the second term is four hundred thirty-two, and the third term is three hundred twenty-four. The Nth term in the series is the first non-integer value. What is the value of N?	[N =] 5
8	Darli buys one cup of coffee every weekday, and two cups of coffee every Saturday and every Sunday. Assuming that June 1st is on a Monday, how many total cups of coffee will she buy during the month of June?	38 [cups]
9	How many ways can you arrange the letters in the word "google", spelled G-O-O-G-L-E?	180 [ways]
10	Eighty-seven point two five is twenty-five percent of what number?	349

# "Math Is Cool" Masters — 2022-23

6<sup>th</sup> Grade — April 29, 2023

Key

## COLLEGE BOWL ROUND #5

#	Problem	Answer
1	As a reduced common fraction, the probability of randomly drawing a red face card from a standard deck is $A$ over $B$ . What is the value of $A$ plus $B$ ?	$[A + B =] 29$
2	What is the largest prime factor of one thousand seven hundred and seventy?	59
3	Neepa takes thirty minutes to complete five-twelfths of an assignment. At this rate, how many more minutes will she need to complete the rest of the assignment?	42 [minutes]
4	An isosceles right triangle has the same area as a rectangle with side lengths 10 and 5 units. What is the length of one of the legs of the right triangle in units?	10 [units]
5	A certain ice cream shop has fifteen flavors. How many different bowls containing two different flavors are possible?	105 [bowls]
6	As an integer, what is the product of one point five times ten to the negative third power and forty times ten to the eighth power?	6,000,000 [or 6 million]
7	Three widgets cost the same as seven gizmos. Eleven gizmos cost the same as nine doodads. How many widgets cost the same as twenty-one doodads?	11 [widgets]
8	If $X$ equals two, $Y$ equals five, and $X$ times $Y$ times $N$ equals four hundred and ninety, what is the value of $N$ ?	$[n =] 49$
9	In a survey of two hundred people about their favorite breakfast drink, eighty-six prefer plain water, twenty-two prefer juice, fifty prefer coffee, and the rest prefer tea. What percent of the people surveyed prefer tea?	21 [%]
10	In cubic inches, what is the volume of a cube with a side length of eleven inches?	1331 [ $\text{in}^3$ ]

# "Math Is Cool" Masters — 2022-23

6<sup>th</sup> Grade — April 29, 2023

Key

## COLLEGE BOWL ROUND #6

#	Problem	Answer
1	Baguettes cost two dollars and ninety-five cents each. Marina buys three baguettes with nine dollars. How many cents will she receive in change?	15 [cents]
2	Let $A$ equal one, $B$ equal two, $C$ equal three, and so on, all the way up to $Z$ equals twenty-six. What is the value of $L$ plus $E$ plus $G$ ?	24
3	What does $X$ equal if two hundred and fifty $X$ minus four thousand equals one thousand five hundred?	$[x = ] 22$
4	A circular spinner with five congruent sections numbered one through five is spun twice. As a reduced common fraction, the probability that the sum of the two resulting numbers is greater than six is $A$ over $B$ . What is the value of $A$ plus $B$ ?	$[A + B = ] 7$
5	Elias takes fifteen minutes to mow the lawn. It takes Martina ten minutes to mow the same lawn. In minutes, how long would it take Elias and Martina working together to mow the lawn?	6 [minutes]
6	The surface area of a rectangular prism whose base has dimensions four inches by seven inches is three hundred and forty-two square inches. In inches, what is the height of the prism?	13 [inches]
7	What is the median of the positive two-digit multiples of twelve that are not also multiples of seven?	48
8	A basketball team has fifteen players. If eighty percent of the players are at least six feet tall, how many of the players are less than six feet tall?	3 [players]
9	How many nickels are needed to make seven dollars and sixty-five cents?	153 [nickels]
10	There are four mugs on a shelf, mug one, mug two, mug three, and mug four. Four is shorter than both one and three. Two is shorter than four, and one is shorter than three. Which number mug is the tallest?	3

# "Math Is Cool" Masters — 2022-23

6<sup>th</sup> Grade — April 29, 2023

Key

## COLLEGE BOWL EXTRA PROBLEMS

#	Problem	Answer
1	A two hundred and fifty-six gigabyte hard drive can hold twelve hundred cat videos or forty-two hundred cat GIFs. The hard drive has eight hundred cat videos. Assuming the remaining space is available, how many cat GIFs can be added to the hard drive?	1400 [cat GIFs]
2	How many two digit positive integers are there which consist of two distinct digits?	81 [integers]
3	Eileen can make ten origami cranes every five minutes. Working at this rate, how many minutes would it take her to make one hundred and eighteen origami cranes?	59 [minutes]
4	As a reduced common fraction, the probability of rolling a prime number when rolling a twelve-sided die numbered one through twelve is $A$ over $B$ . What is the value of $A$ plus $B$ ?	$[A + B =] 17$
5	The volume of a cone with a radius of eight centimeters and a height of fifteen centimeters is $A$ times pi cubic centimeters. What is the value of $A$ ?	$[A =] 320$
6	What is the value of $X$ if ninety $X$ plus one hundred twenty equals eighty-five $X$ ?	$[x =] -24$
7	On the coordinate plane, find the distance in units between the points two comma negative one and eight comma seven.	10 [units]



# Proctoring Overview

You will receive a room packet envelope with the schedule and College Bowl rotations on the front. Each room packet includes:

- 1) the proctor instructions and the general instructions that you will be reading,
- 2) the proctor question/answers packet (this needs to be carefully controlled), and
- 3) sets of Mental Math, Individual, Multiple Choice, Team, and Triple Jump test materials.

(If not in the room packet, the proctor supervisor will provide blank scratch paper.)

When you receive the room packet, count to ensure that you have the correct number of tests for each event (16 Mental Math & Individual, 4 of each of the team events).

## Key Points

- Act professional; focus on what you are doing.
- Your job is to proctor the students; that is, you administer tests, give time warnings, & monitor students for proper test taking behavior to ensure competition integrity and avoid issues like failing to put answers on the answer sheet.
- The proctor packet has Mental Math and College Bowl questions/answers. Keep the packet secure! Avoid opportunities for competitors to see the tests or answers.
- Student/school names and team numbers are critical on the answer sheets. Make sure that students fill out such identifying information.
- Keep track of time, and provide appropriate time warnings. Keep to the schedule as close as possible. Wait between events, if needed.
- Read & know the rules—competitors & spectators will, and they will call you on it.
- On questions that you read, read smoothly, enunciate clearly, and don't read too fast.
- If unsure of how to deal with an issue/question/concern, flag down the proctor supervisor and ask.
- Be respectful of your classroom — leave it tidy and arranged exactly as you found it. We don't want any displeased teachers!!
- Use the quick-reference guide on the next page for room setup and key information.

## Schedule

*Each of the 6 events includes about 5 minutes at the start for reading instructions or rearranging the room.*

9:15 - 9:45	Coaches register (Entrance)	12:00 – 12:35	Lunch break
9:45 – 9:55	Orientation (TBD)	12:40 – 12:55	College Bowl #1
9:55 – 10:00	Students go to testing rooms	12:55 – 1:05	College Bowl #2
10:00 – 10:15	Mental Math	1:05 – 1:15	College Bowl #3
10:15 – 10:55	Individual Test	1:15 – 1:25	College Bowl #4
11:00 – 11:20	Team M.C. Test	1:25 – 1:35	College Bowl #5
11:20 – 11:40	Team Test	1:35 – 1:45	College Bowl #6
11:40 – 12:00	Triple Jump	2:00	Awards Ceremony (TBD)

### 1. Mental Math

**Configuration:** Students at individual desks spread out in the classroom. Alternating desks, students not next to teammates.

**Scheduled Time:** 10-10:15 AM (read instructions & test)

**Duration:** 30 seconds per question maximum (beginning after the 2<sup>nd</sup> reading)

**Give Time warning at:** 5 seconds

**Number of questions:** 8 (all students do the same questions)

**Proctor Actions:** Read each question twice, reading clearly and not too fast. Start the 30 second clock after the 2<sup>nd</sup> reading.

**Key Points:** Start by reading "General Instructions" then Mental Math instructions. Make sure everyone writes their name, school & team number on the answer sheet. No talking allowed. Except for the answer, no writing allowed. Collect answer sheets and organize by team number, then alphabetically by first name of competitor, & staple sheets for the same team together.

### 2. Individual Test

**Configuration:** Students at individual desks; same arrangement as for Mental Math.

**Scheduled Time:** 10:15 AM (read instructions),  
10:20 - 10:55 (test)

**Duration:** 35 minutes

**Give Time warning at:** 5 minutes & 30 seconds

**Number of questions:** 40

**Proctor Actions:** Ensure appropriate test-taking behavior. Prep for next event (or furtively read College Bowl questions to yourself).

**Key Points:** Read "Individual Test" instructions. Make sure everyone writes their name, team number, school, proctor name, & room number down on the answer sheet. Collect answer sheets, organize by team, then alphabetically by first name of competitor, and staple sheets for same team together.

### 3. Team Multiple Choice Test

**Configuration:** Groups of 4 desks, with the groups spread out in the classroom.

**Scheduled Time:** 11:00 AM (read instructions),  
11:05 - 11:20 AM (test)

**Duration:** 15 minutes

**Give Time warning at:** 5 minutes & 30 seconds

**Number of questions:** 10

**Proctor Actions:** Ensure appropriate test-taking behavior. Prepare for next event.

**Key Points:** Read Mult. Choice instructions. Students can talk quietly & work together.

### 4. Team Test

**Configuration:** Groups of 4 desks spread out in the classroom (same as Team Mult. Choice).

**Scheduled Time:** 11:20 AM (read instructions),  
11:25 - 11:40 (test)

**Duration:** 15 minutes

**Give Time warning at:** 5 minutes & 30 seconds

**Number of questions:** 10

**Proctor Actions:** Ensure appropriate test-taking behavior. Prepare for next event.

**Key Points:** Read Team Test instructions. Need to have school & team number on answer sheet. Students can talk quietly & work together.

### 5. Triple Jump

**Configuration:** Groups of 4 desks spread out in the classroom.

**Scheduled Time:** 11:40 AM (read instructions),  
11:45 - 12:00 PM (test)

**Duration:** 15 minutes

**Give Time warning at:** 30 seconds and 5 seconds before each of three submittals.

**Number of questions:** 10

**Proctor Actions:** Ensure appropriate test-taking behavior. Collect Submittals #1, #2 and #3 at 5, 10 and 15 minutes.

**Key Points:** Read Triple Jump instructions. Need to have school & team number on answer sheets. There are THREE answer sheets and submittals. Students can talk quietly & work together

### 6. College Bowl

**Configuration:** Row of 9 desks (side by side) at the front of the room (CBA device on center desk).

**Scheduled Time:** 12:40 PM (read instructions),  
12:45 - 1:45 PM (test)

**Duration:** 45 seconds per question (30 seconds per question if there is only one team, who will be only going against the clock)

**Give Time warning at:** 5 seconds

**Number of questions:** 10 per round, 6 rounds total

**Proctor Actions:** Read each question twice, reading clearly and not too fast. Start 45 (or 30) second clock after the 2<sup>nd</sup> full reading. Mark tally on white board as questions are answered and transfer the numeric total to the score sheets.

**Key Points:** Event is collaborative, talking is allowed. For a wrong answer, just say, "That is incorrect." (no verbal/visual clues that could be interpreted by the other team to arrive at an answer).

# Summary of MIC Proctoring

(for proctors to read to themselves)

Pass out materials (answer sheet/test packets, scratch paper) for the current event to individuals or teams (as appropriate) so they can fill in the name, school, and team number information (very important!). Tell students to not lift the cover sheet or turn over the paper until you give the signal to start. Read the general instructions as the first item at the beginning of the competition (before Mental Math). Read the event-specific instructions just prior to each event and ask if there are any relevant questions. After reading the instructions, you can signal students to begin. Make sure one proctor is watching the time and giving appropriate time warnings (e.g., "five minutes remaining"). At the end of the event, tell competitors to stop work. Collect, sort, & staple the answer sheets (as appropriate) and keep them secure until handed off to a runner.

For the Mental Math/Individual tests, arrange students scattered throughout the classroom with **no student next to another student from their own school**. For the team tests, students will be in groups of 4 desks. College Bowl will require a line of 9 desks side-by-side across the front of the classroom.

For College Bowl, place the College Bowl apparatus (CBA) on a central desk in the line of desks at the front (4 desks on either side of the central one). One proctor will likely need to hold the CBA in place during the College Bowl rounds. Turn the apparatus on by depressing the button or flipping the dip switch. Students may try out the CBA prior to the 1<sup>st</sup> question. Note: while one light is blinking, the other light is locked out. There is no need to "reset" the device, just let the light finish blinking and it is ready to go.

Do not read the answer for College Bowl when you read the question (they are both on the same page). In College Bowl, if an incorrect answer is given, simply say "That is incorrect" and do not give any other cues about the answer (e.g., don't say "sorry, you were close" or exhibit interpretable body language). If both teams fail to supply a correct answer, announce what the correct answer was.

If there is an irregularity (i.e., lack of honesty, poor sportsmanship), make a note of the circumstances, flag the answer sheet, and report the issue to the proctor supervisor.

At the end of the day, return the desks to their original arrangement, recycle any unwanted test materials & used scratch paper, erase any marks you made on the whiteboard, and generally make sure the classroom is tidied up. Return the CBA, the room packet envelope, the proctor instructions, the contest rules packet, the proctor packet of questions, extra scratch paper, and unused test material to the proctor supervisor.

# Detailed Instructions for Proctors

## Grades 4-8

NO CALCULATORS ALLOWED ON ANY TESTS!

1. Check to make sure you have everything in your packet.
  - A. **Mental Math:**
    1. 16 - colored Mental Math answer sheets
    2. Mental Math questions with answers (in the Proctor Packet)
  - B. **Individual Test:** 16 individual tests, with colored answer sheets attached
  - C. **Team Multiple Choice Test:** 4 team multiple choice packets (stapled), each containing 4 tests plus one colored answer sheet on top
  - D. **Team Test:** 4 team test packets (stapled), each containing 4 tests plus one colored answer sheet on top
  - E. **Triple Jump:**  
4 team test packets (stapled), each containing 4 tests plus three colored answer sheets on top (one per submittal).
  - F. **College Bowl:**
    1. 4 - College Bowl score sheets
    2. College Bowl questions - 6 rounds (in the Proctor Packet)
  - G. Scratch paper (to be handed out as needed, but try not to waste it)
  - H. Electronic College Bowl Apparatus (CBA; usually distributed at dinner break)

ALL **COLORED** ANSWER SHEETS WILL BE COLLECTED BY YOU AND WILL BE TAKEN TO THE SCORING ROOM (by RUNNERS) AS SOON AS THEY ARE FILLED OUT BY COMPETITORS. COMPETITORS CAN KEEP ALL OF THE WHITE SHEETS, IF THEY WOULD LIKE (OTHEWISE COLLECT THEM FOR RECYCLE).

If you are missing anything, you can go get it before the opening ceremony. After the opening ceremony, contact the proctor supervisor/scoring room.

2. Take a photo or draw a picture on the whiteboard of how the classroom is laid out (so that it can be returned to its original configuration following the competition). Then set up the classroom desks for the first event (Mental Math).

**Respect the teacher whose room you are using. Do not touch their computer or other items. Do not erase anything on their board. Leave the room tidy & in the exact original layout.**

### **Mental Math**

3. Arrange desks in a configuration suitable for individual testing (rows/grid of desks all facing forward, students in separated/alternating desks).
4. Put the Mental Math answer sheets face up on the desks such that students are spread out. Wait for students to arrive. You can fill out the proctor name and room

number (and perhaps team numbers) on all blank answer sheets, if you like. Read over the questions so you will be prepared to read them out loud.

5. After students sit down, check to make sure that no one from the same team is seated next to each other (i.e., "Team xxx, raise your hands."). Ask them to move, if needed.
6. **Check to make sure that students put their full name, school name, team number, and room number on their answer sheet and that the information is legible.**
7. Read the "GENERAL INSTRUCTIONS" (in the Proctor Packet) to the students. Then, read the "MENTAL MATH" instructions (in the Proctor Packet) to the students.
8. Begin the testing. Read each of the eight Mental Math questions to all of the students in the room, per the instructions.
9. At the conclusion of Mental Math, collect the answer sheets. Organize the answer sheets by team number, then alphabetically by first name of competitor. Staple each team's set of four answer sheets together. Promptly hand the packets of answer sheets to your runner for conveyance to the scoring room.

### **Individual Test**

10. The seating configuration will remain unchanged (no swapping seats).
11. Hand out Individual Test packets with the colored blank answer sheet facing up. **Check to make sure that students put their full name, school name, team number, and room number on their answer sheet and that the information is legible.**
12. Read the "INDIVIDUAL TEST" instructions (in the Proctor Packet) to the students and begin the testing at the appointed time.
13. While students are taking the Individual Test, monitor the students for proper test-taking behavior and watch the time to provide 5-minute and 30-second warnings. Make sure students are writing answers on the answer sheet (not the test question pages). During this time you can also get the Individual Multiple Choice tests ready, read through the rules of subsequent events, and (carefully/secretively) look ahead to review the College Bowl questions (i.e., to avoid stumbling over the wording when it comes time to read the questions aloud). You will have observers in the room watching the College Bowl rounds, so make sure you understand the rules, how timing works, etc.
14. At the conclusion of Individual Test, collect the answer sheets. Organize the answer sheets by team number, then alphabetically by first name of competitor. Staple each team's set of four answer sheets together. Promptly hand the packets of answer sheets to your runner for conveyance to the scoring room. Students may keep or recycle their test question packets.

## Team Multiple Choice

15. Change the room set-up to groups of 4 desks together so students can work as a team.
16. Hand out the tests and have teams fill out the top portion of the answer sheet. **Check answer sheets to make sure they are filled out correctly (school, team #, etc.).**
17. Read the "TEAM MULTIPLE CHOICE" instructions (in the Proctor Packet) to the students and begin the testing at the appointed time.
18. Monitor the students for proper test-taking behavior (talking is allowed), watch the time, and provide 5-minute and 30-second warnings. While students are taking the Team Multiple Choice test, get the Team Tests ready.
19. At the conclusion of the test, collect the answer sheets & hand them off to the runner.

## Team Test

20. Keep the same seating arrangement in groups of four. Hand out the Team Test packets and have teams fill out the information at the top of the colored answer sheet. **Check the answer sheets to make sure they are filled out correctly (school, team #, etc.).**
21. Read the "TEAM TEST" instructions (in the Proctor Packet) to the students and begin the testing at the appointed time.
22. Monitor the students for proper test-taking behavior (talking is allowed), watch the time, and provide 5-minute and 30-second warnings.
23. At the conclusion of the test, collect the answer sheets & hand them off to the runner.

## Triple Jump

24. Keep the same seating arrangement in groups of four. Hand out the Triple Jump Test packets and have teams fill out the information at the top of EACH OF THE THREE colored answer sheet. **Check the answer sheets to make sure they are filled out correctly (school, team #, etc.).**
25. Read the "Triple Jump TEST" instructions (in the Proctor Packet) to the students and begin the testing at the appointed time.
26. An Answer Sheet must be submitted every 5 minutes (labeled: Submittal #1, Submittal #2, Submittal #3). Give time warning at 30 seconds and 5 seconds prior to each submittal. Collect the submittals promptly at 5 minutes, 10 minutes and 15 minutes.
27. At the conclusion of the test, staple the three answer sheets for each team together in order: Submittal #1 (top), #2, #3 (bottom) & hand them off to the runner.

28. At the conclusion of the Triple Jump, release the students for their break. If there is anything left (i.e., answer sheets) that should have been taken to the scoring room, give those to the runner or have a proctor take it to the scoring room now.
29. Set up your room for the College Bowl rounds and tidy up the room before you go to break. Set up a line of 9 desks side by side facing the front of the room. One team will be on each side (doesn't matter which) and the College Bowl apparatus will be stuck down on the desk in the middle. Another row of 8 desks should be set up in the middle of the room for the two teams not competing in a round. Other desks should be moved to the back of the room in an orderly fashion for the spectators.
30. Take your packet of College Bowl questions with you during break to keep them secure! Do not leave them in the room!

### **Dinner Break**

31. AT BREAK — Eat dinner in the proctor room. Pick up your College Bowl apparatus (CBA) at this time. If you haven't already, you may want to read over the College Bowl questions to make sure you will be able to pronounce everything properly. Return to your room in time to place the CBA in position.

### **College Bowl Rounds**

32. Place the CBA on the middle desk of the line at the front of the room (you may want to moisten the suction cups with a film of water). One proctor may need to hold the device down (and do timing). Do not press the button to "reset" the CBA (it's an on/off switch).
33. You will have the same teams that were previously in the room for the duration of all College Bowl rounds — if you have an extra/different team, they are in the wrong room and can be disqualified if they hear the questions! Help get them to the correct room.
34. Fill out the score sheets for each team in your room with their school name and team number. Call up the first 2 teams according to the sequence on the room envelope.
35. You will be reading Round #1 questions to two teams while the other two teams (and any spectators) wait in the back of the room out of line of sight of the competitors. Refer to the College Bowl schedule (on your room envelope) to see which two teams compete in each round. If a round only has one team, they will be competing against the clock and thus will have 30 seconds to answer, not 45 seconds. Record the final scores for each team on their score sheets (which you hold on to) after each round. Rounds 2-6 work the same way. Refer to the schedule to make sure the correct teams are competing at the correct time. Don't get ahead of schedule (or behind, for that matter!). If you finish a round early, please wait until the appointed time to start the next round. If you have any problems (including anyone questioning the rules or a decision made by a proctor) contact the proctor supervisor.

36. Who is keeping score? Who is keeping track of the time? YOU ARE !!!
37. Read the "COLLEGE BOWL" instructions (in the Proctor Packet) to all the students (just one time), then begin the testing for each round at the appointed times.
38. If you mis-read a question, replace it with one of the extra questions.
39. If a parent/coach/student protests an answer, make a note of the situation (the test, the problem number, who answered, what their answer was, etc.) and kindly state that the coach should bring up the issue with the contest director. Proceed as normal, scoring the question based on the answer key.
40. At the conclusion of all College Bowl rounds, get the score sheets promptly to the scoring room (either yourself or via a runner).
41. Release your group to the awards ceremony no earlier than 7:45 PM to avoid causing a disruption to other rooms. Have students help re-set the room.
42. At the end of the day, return the desks to their original arrangement, collect all scratch paper, erase any marks you made on the whiteboard, and generally make sure the classroom is tidied up. Return the College Bowl apparatus, proctoring envelope, and residual material to the proctor supervisor.



# General Instructions

- Good sportsmanship is expected throughout the competition by all involved (competitors and observers). Display of poor sportsmanship will result in disqualification.
- Competitors may not use calculators or any other aids on any portion of this contest.
- Unless stated otherwise: Note: for 2023 tests, all answers are integers.
  - Express all rational, non-integer answers as common fractions, except in problems dealing with money, where you should give the answer as a decimal rounded to the nearest cent.
  - For fifth grade and up, all fractions and ratios must be reduced to simplest form, all radicals must be simplified, and all denominators must be rationalized.
  - Do not round or approximate answers. Leave answers in terms of  $\pi$  or other irrational quantities (e.g.,  $\sqrt{2}$ ), where applicable.
- Units are not necessary as part of your answer, unless it is a problem that deals with time, in which case, AM or PM is required. However, if you choose to use units, they must be correct.
- Record all answers on the colored cover sheets in the answer column only.
- **Be sure that the student name, school, team number, etc. has been filled out at the top of each answer sheet.**
- Tests will be scored as a 0 if answers are not recorded correctly on the answer sheets.
- Blank answer sheets and answer sheets with no name will be scored as a 0.

# Mental Math Instructions

All students in the room will concurrently be asked the same eight questions in this individual test. When it is time to begin, the proctor will read the first question twice. You may not do any writing or talking while arriving at a solution. Once you have a solution, record it on the sheet in front of you. **You may not change or cross out answers once you have written an answer down. If there are eraser marks, write-overs, or crossed-out answers, they will be marked wrong.** Once all students have laid their pencils on the

desk, another question will be asked. If a student doesn't lay his or her pencil down, the maximum wait time is 30 seconds after completion of the second reading of the question before the next question is read. You may continue to work on a problem (in your head) while the next question is being read. The raw score is 1 point per correct answer.

## Individual Test Instructions

You will have 35 minutes to work on the Individual test, which consists of 40 questions. When you are prompted to begin, tear off the colored sheet and begin testing. Make sure your name and school are recorded on the answer sheet. The first 30 questions are worth two points each and questions 31-40 are worth 3 points each. Record your answers on the score sheet. No talking during the test. You will be given a 5 minute warning.

## Team Multiple Choice Instructions

You will have 15 minutes to answer 10 multiple choice questions as a team. This test is the only test where you will be penalized for incorrect responses. You will receive two points for a correct letter response, zero points for leaving it blank, and minus one point for an incorrect response. When you are prompted to begin, tear off the colored answer sheet, pass out a copy of the test to each team member, and begin testing. **ONLY a letter response should be listed as an answer on this answer sheet.**

## Team Test Instructions

You will have 15 minutes to answer 10 questions as a team. When you are prompted to begin, tear off the colored answer sheet and give a copy of the test to each of your team members and begin testing. Each problem is scored as a 1 or 0. Record all answers on this colored answer sheet.

# Triple Jump Instructions

You will have 15 minutes to answer 10 questions as a team. However, you will submit a set of answers every 5 minutes. Notice that your answer sheets are labeled Submittal #1 (to be submitted after 5 minutes), Submittal #2 (to be submitted after 10 minutes) and Submittal #3 (to be submitted after 15 minutes). Each problem is scored as a 1 or 0 on each of the three submittals, for a total of 30 points. Answers that are written on one submittal sheet do NOT carry over to the next submittal sheet - they need to be entered again. You may change your answer for a question from one submittal to the next, if you feel that your previous answer was incorrect.

# College Bowl Instructions

## **Read these to the competitors before the first round:**

To maintain the integrity of the competition, spectators must stay in this room during a round of College Bowl questions. Once all readings for a round have been completed, you may leave.

All competitors must be facing the front of the room in one row. Teams not competing in the current round need to be behind the front row and in front of the spectators. All spectators need to be behind the competitors at the back of the room.

A maximum of ten questions per round will be scored. It is OK for both teams to score the same number of points! The proctor will record the points earned on each team's score sheet, which is retained by the proctor.

You may use scratch paper and pencil. You may talk with your team members while arriving at a solution.

An Electronic College Bowl Apparatus (CBA) will be used to identify the team who is first to have an answer.

During these rounds, each question will be read twice and a maximum time of 45 seconds after the second reading of the question is completed will be allowed for a team to answer. If a team buzzes in after the second reading and gives an incorrect response, the other team has the remainder of the 45 seconds to respond. A team is allowed only one attempt at buzzing in and answering per question. You may interrupt (buzz in) while a question is being read, however, if you do, the proctor will stop reading, and an immediate response is needed. If the correct response is given, the proctor will proceed to the next question. Otherwise, the question will be re-read for the other team, making sure it has two full readings. If an immediate response is not given after a team buzzes in, their lack of an answer in a timely manner is considered incorrect. In the event that only one team is competing in a round (i.e., one team is absent), the team competing will have a maximum of 30 seconds after the completion of the second reading in which to buzz in. The proctor will give a 5-second time warning.

Wait to be acknowledged by the proctor before giving an answer. This avoids the situation of blurting out an answer when the other team buzzed in first.

If two students from the same team answer at the same time with different answers, the answer will be considered incorrect.

If a problem arises with one of the questions, an extra question will be asked to replace that question.

If the round finishes early, you need to stay in the room for the remaining time.

# **Mental Math Questions**

## **College Bowl Questions/Answers**